

TACO: Visualizing Changes in Tables over Time

Christina Niederer, Holger Stitz, Reem Hourieh, Florian Grassinger,
Wolfgang Aigner, and Marc Streit



@ChriNiederer, @holgerstitz, @Reem7, @wolfgangaigner, @marc_streit

Have you ever compared tables?



Insertions? Deletions? Value changes? Order changes?

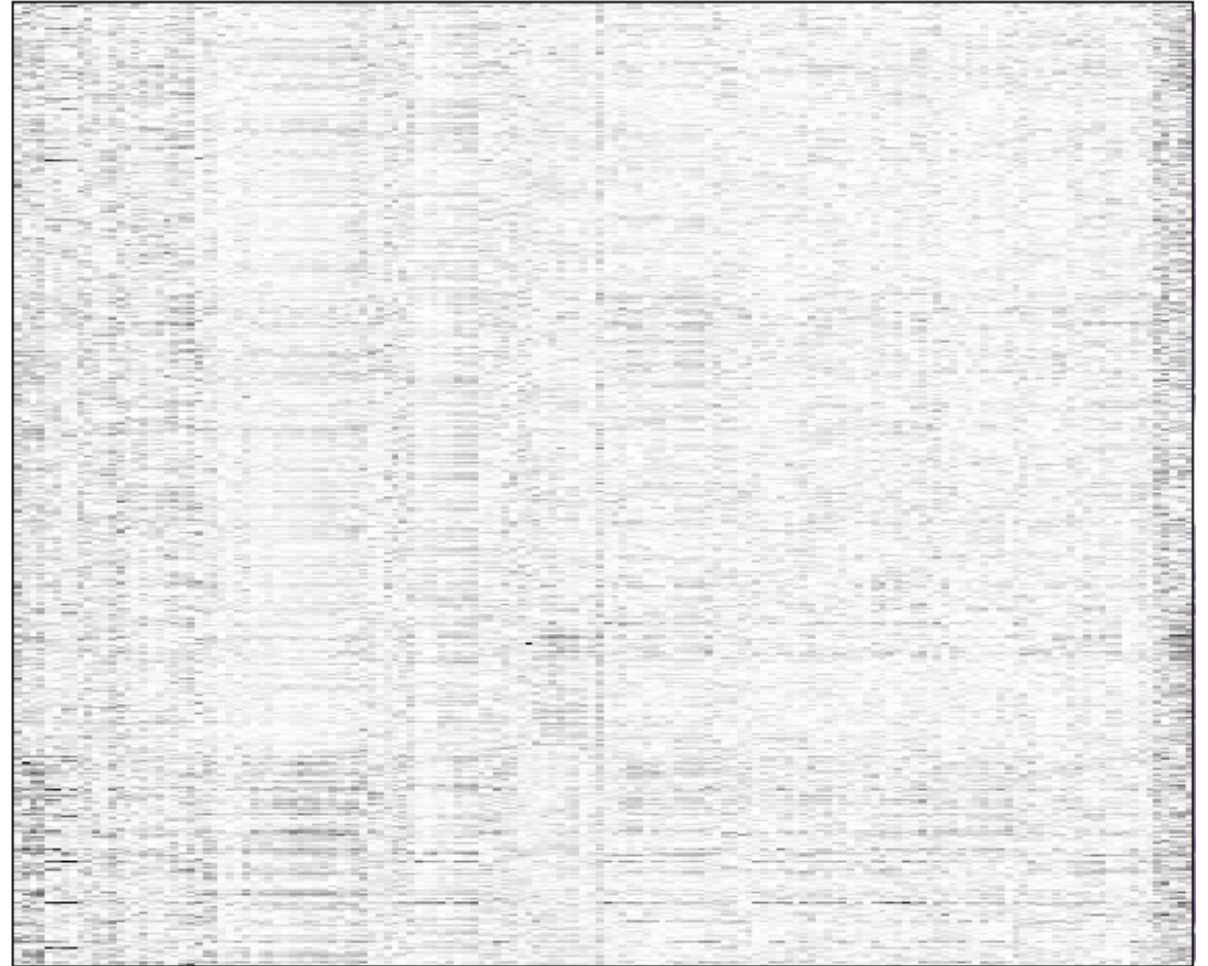
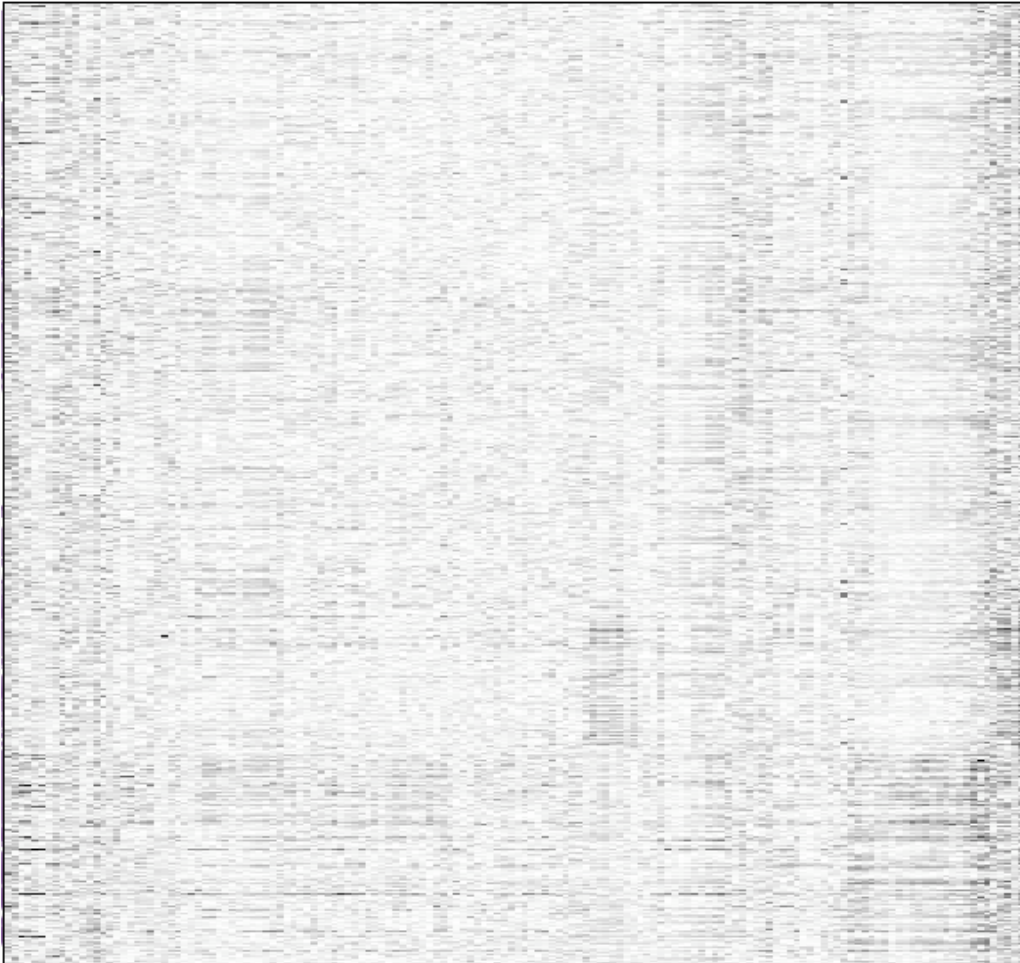

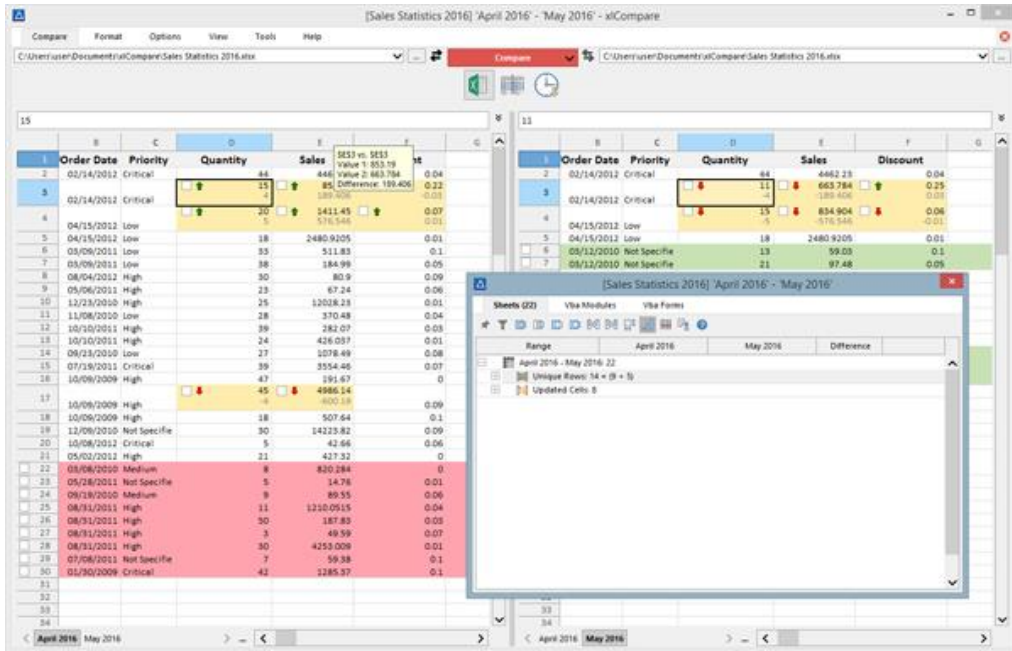

xlCompare

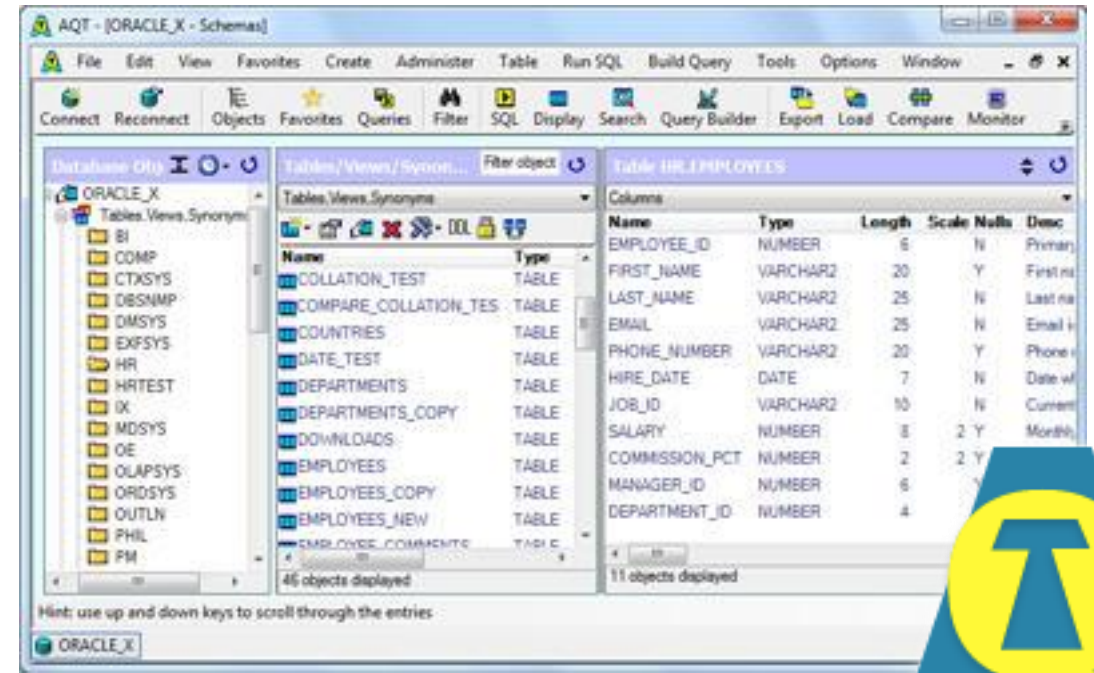

AQT

Original table	Modified table	Difference
bridge	designer	length
Brooklyn	J. A. Roebling	1595
Williamsburg	D. Duck	1600
Queensborough	Palmer & Hornbostel	1182
Triborough	O. H. Ammann	1380.383
Bronx Whitestone	O. H. Ammann	2300
Throgs Neck	O. H. Ammann	1800
George Washington	O. H. Ammann	3500
Spamspan	S. Spamington	10000

Original table	Modified table	Difference
@@	bridge	designer
	Brooklyn	J. A. Roebling
+++	Manhattan	G. Lindenthal
→	Williamsburg	D. Duck—L. L. Buck
	Queensborough	Palmer & Hornbostel
---	---	---
	George Washington	O. H. Ammann
---	Spamspan	S. Spamington

Original table	Modified table	Difference
bridge	designer	length
Brooklyn	J. A. Roebling	1595
Manhattan	G. Lindenthal	1470
Williamsburg	L. L. Buck	1600
Queensborough	Palmer & Hornbostel	1182
Triborough	O. H. Ammann	1380.383
Bronx Whitestone	O. H. Ammann	2300
Throgs Neck	O. H. Ammann	1800
George Washington	O. H. Ammann	3500

daff

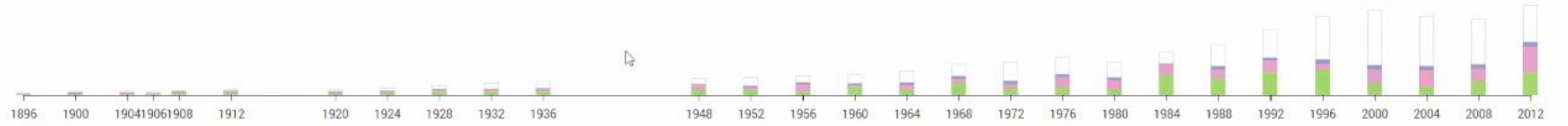

Select two time points on the timeline to get more information.

Load Detail View

Select two time points on the timeline to get more information.

User Tasks



T1: Identify the types of changes

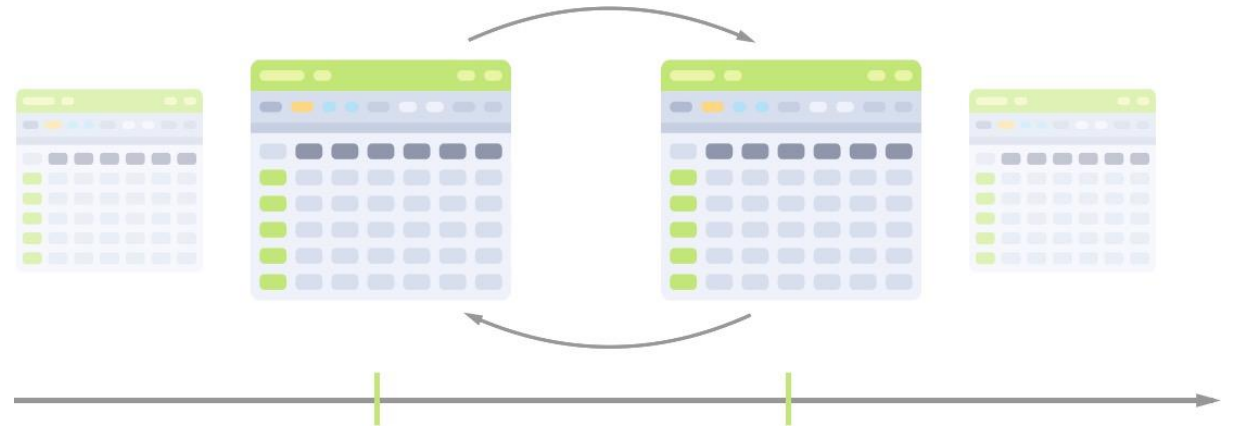

T3: Compare one table at two particular time points



T2: Compare multiple table versions over time

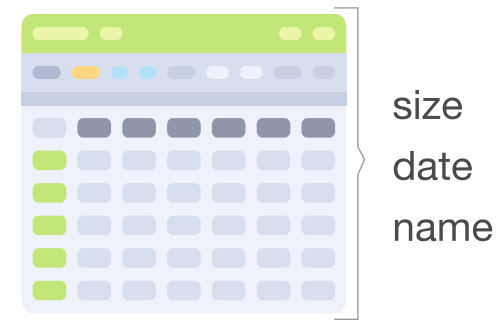

T4: Present raw data tables and meta-data

Change Types

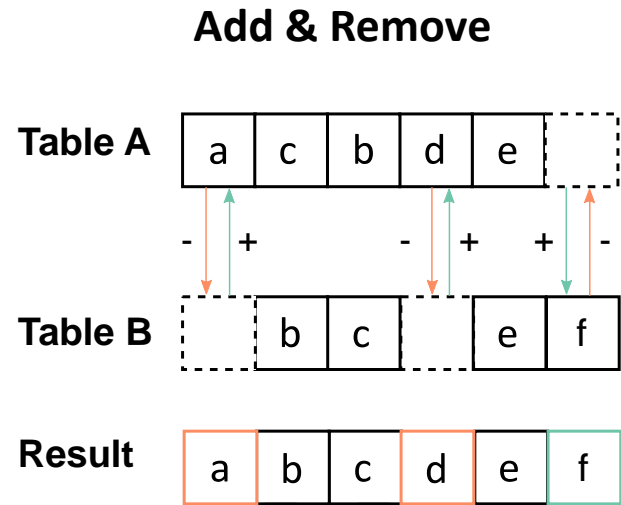

**Structural
Changes**

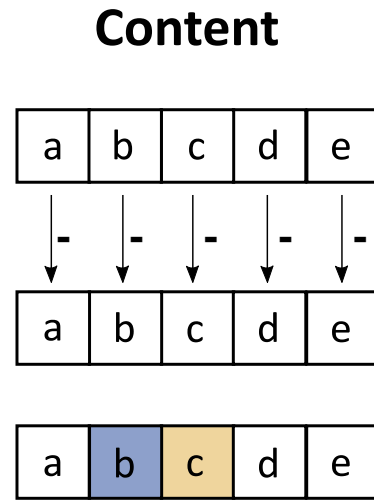

**Content
Changes**

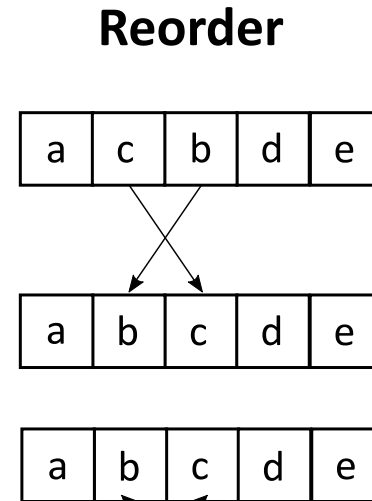

**Reorder
Changes**

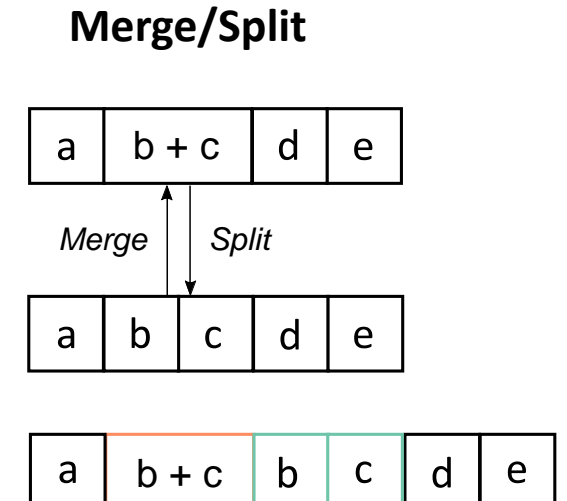

**Merge/Split
Changes**

Visualization Design

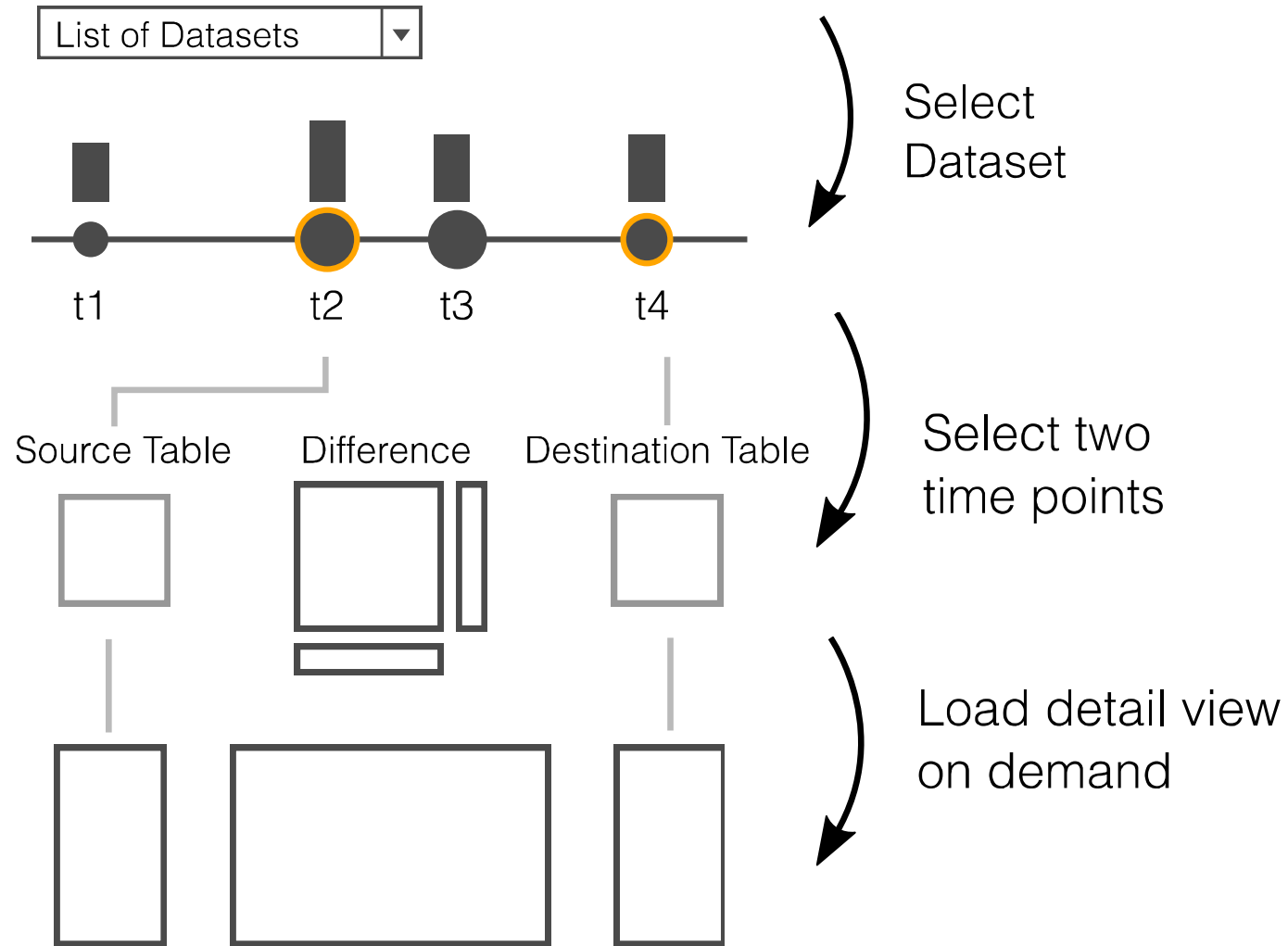

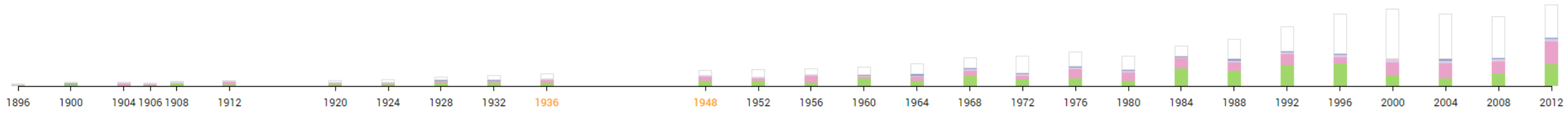

LEVEL 1: Change Overview Timeline

Rows
19 Countries

Columns
36 Disciplines



Rows
21 Countries

Columns
38 Disciplines

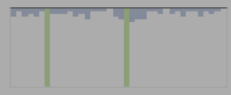

Load Detail View

Normalized Content Change
-1 0 1

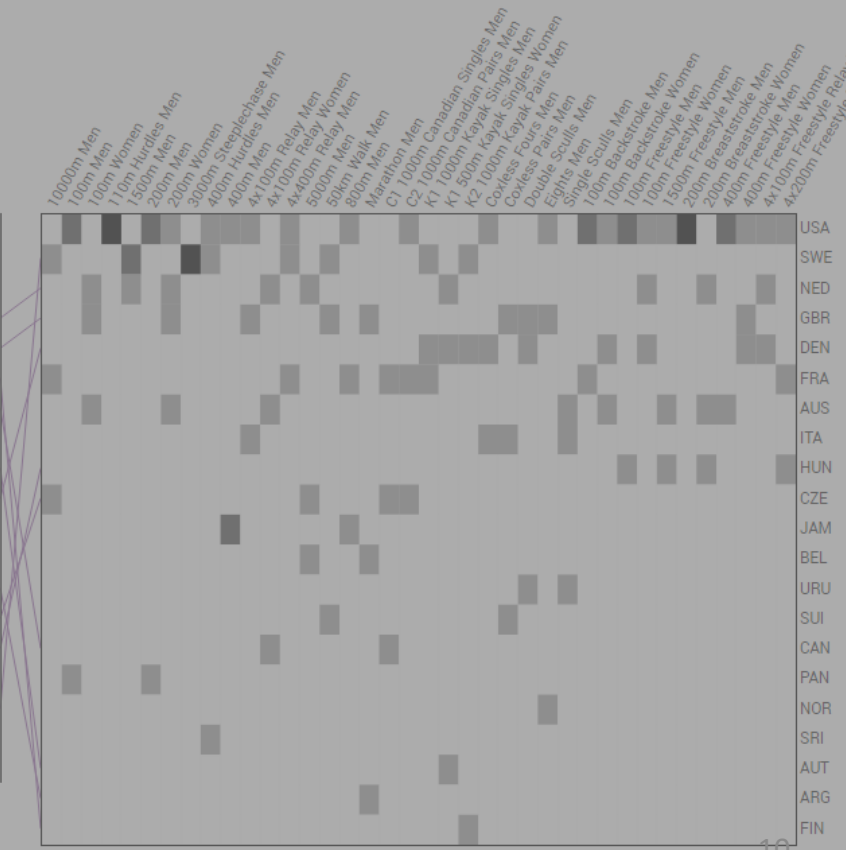
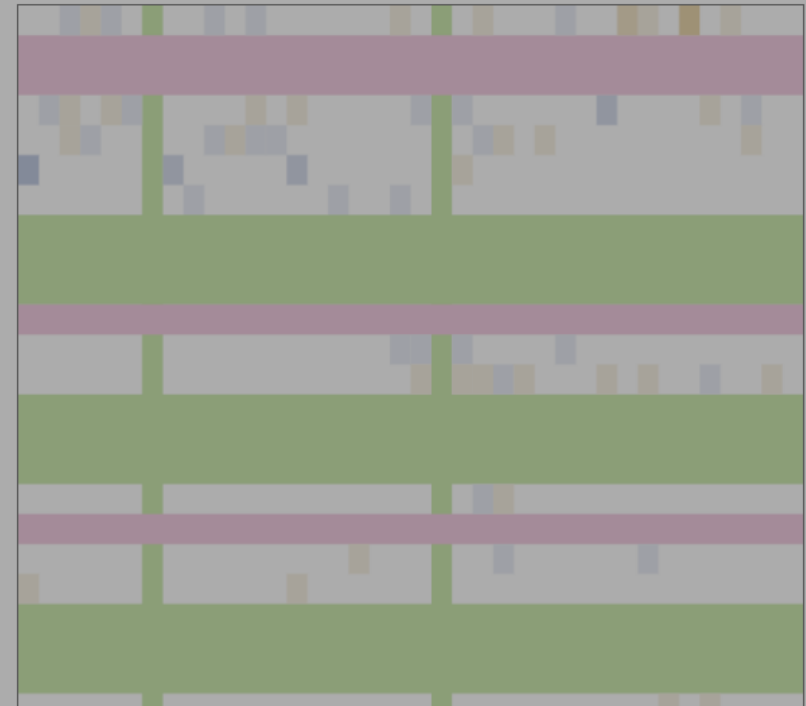
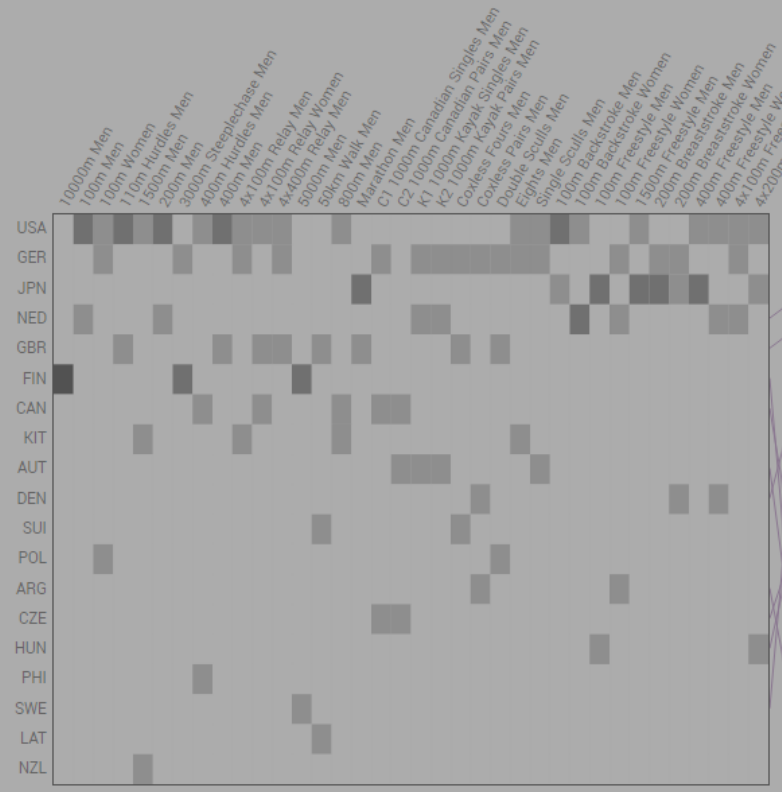

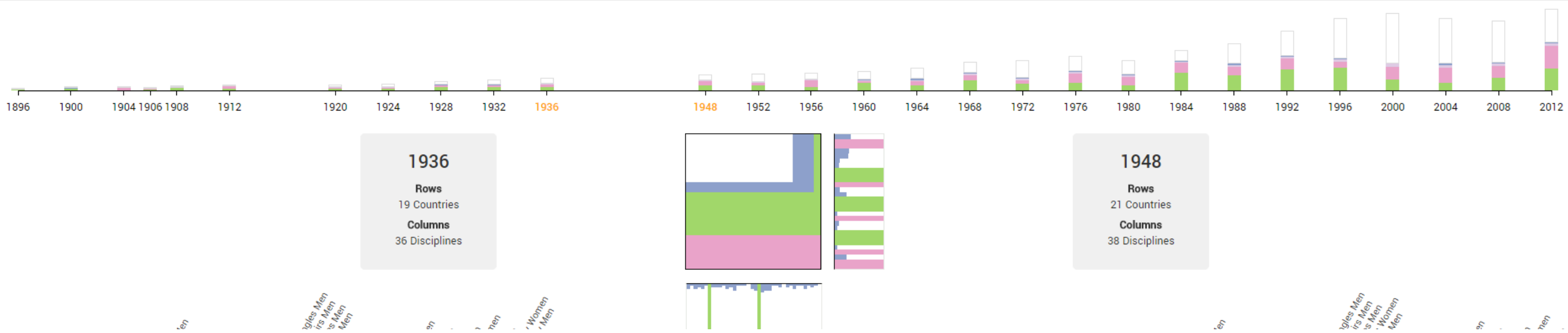

LEVEL 2: Aggregated Pairwise Comparison

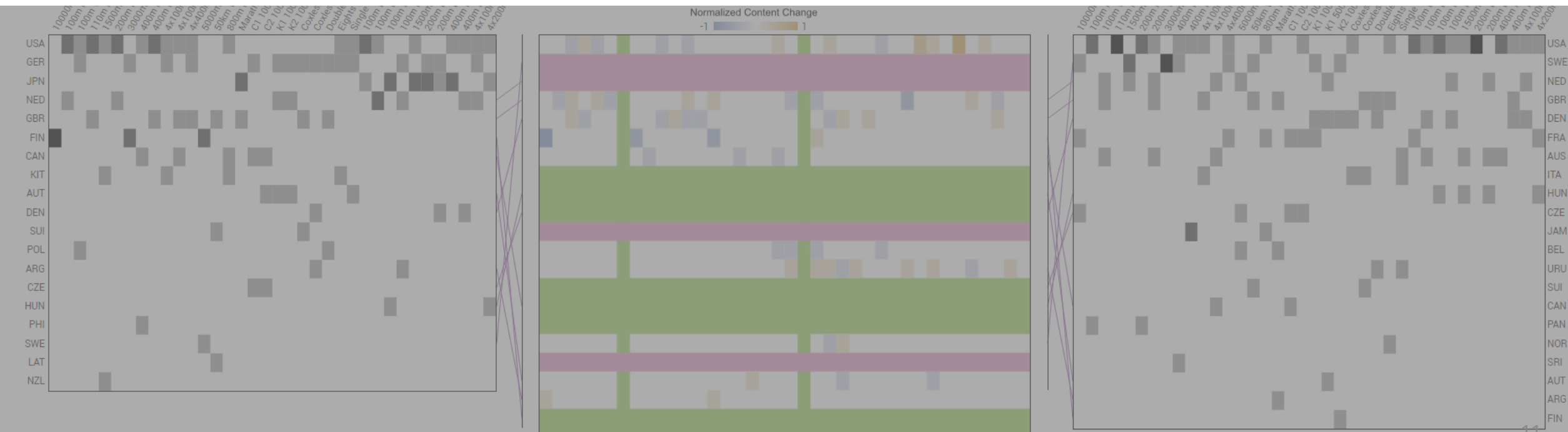

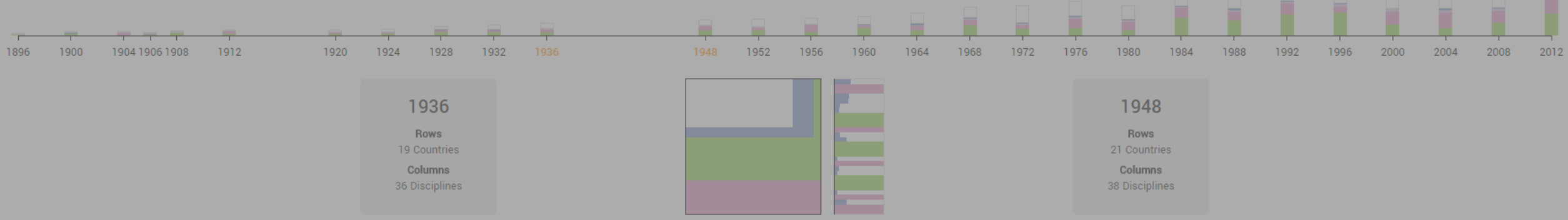

LEVEL 3: Detailed Pairwise Comparison

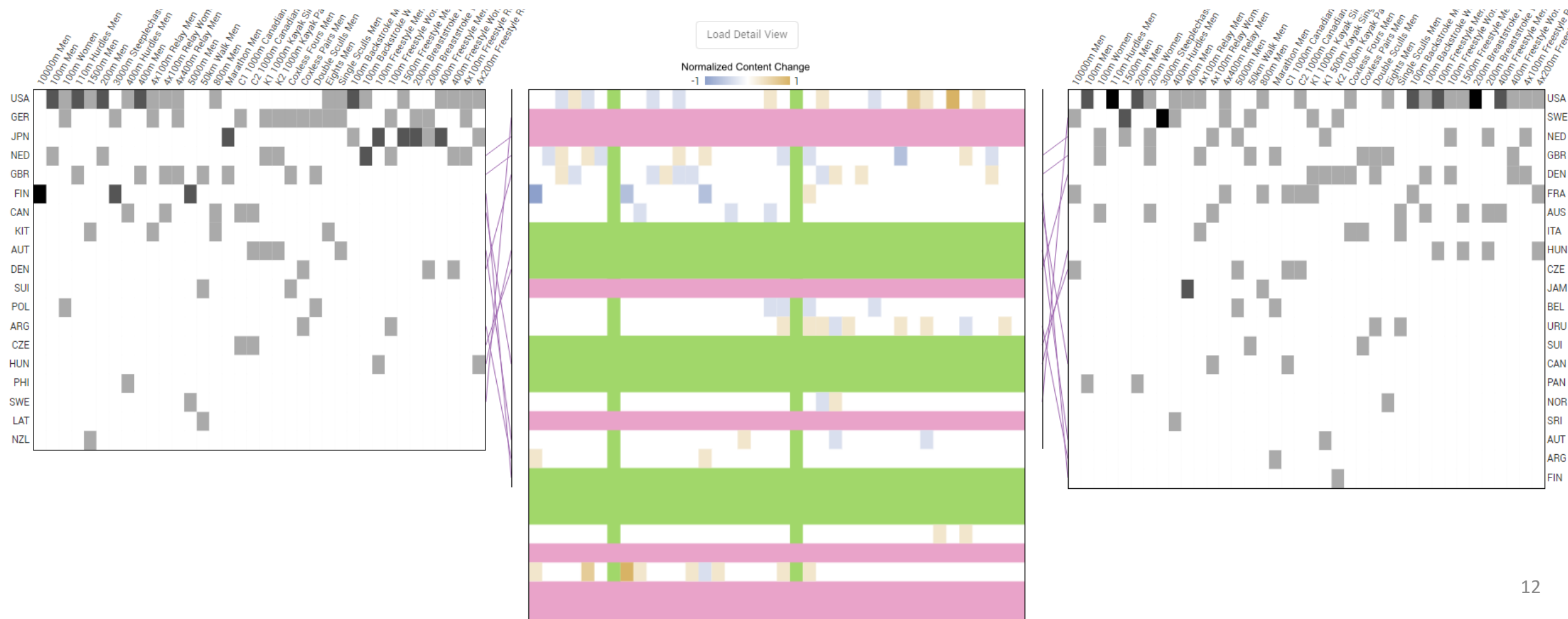

Usage Scenario

Summer Olympic Games

rows = countries, columns = disciplines



Level 1: Change Overview Timeline

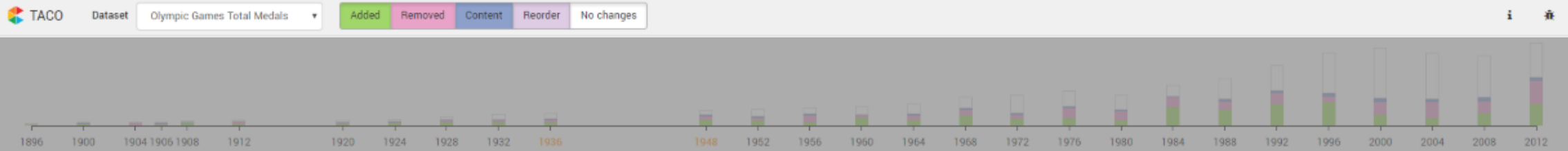

Level 1: Change Overview Timeline

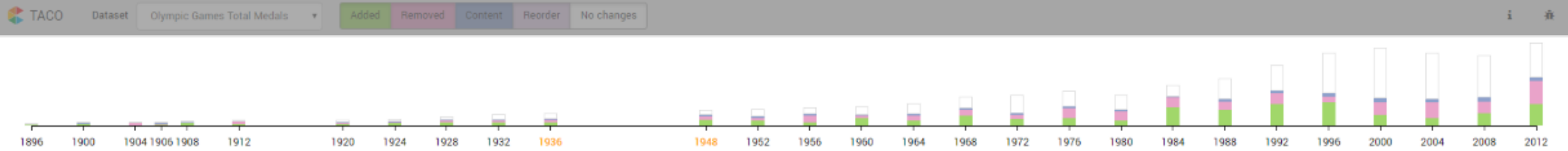

Level 2: Aggregated Pairwise Comparison

(a) Diff Table

	c1	c2	c3	c4
r1	a	a	a	a
r2				a
r3	c	c	c	a
r4			c	a
r5	d	d	d	d
r6	c			a
r7				a
r8		c		a
r9				a
r10				a

(c) Rows

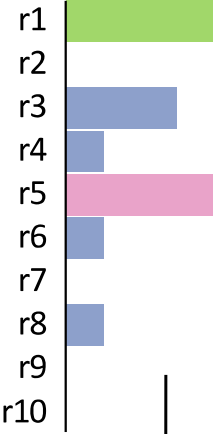

(e) Diff Histogram (Rows)

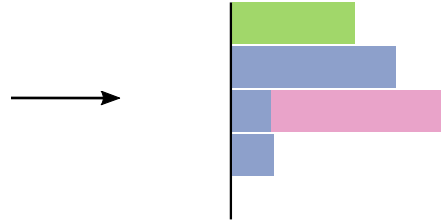

(d) Columns

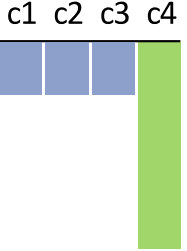

Columns Ratio
0.56 0.19 0.25

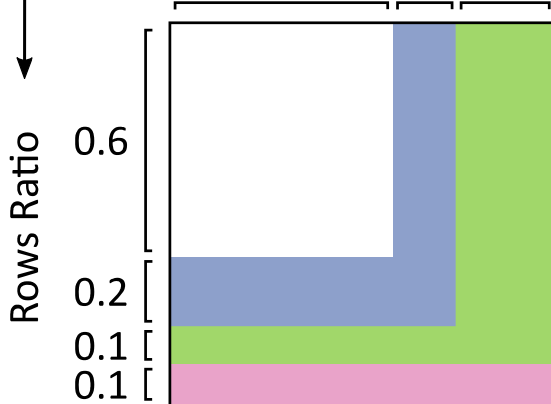

(f) Diff Histogram (Columns)

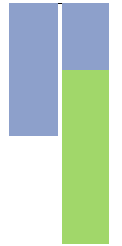

Legend

- Content Change
 - Added
 - Removed
 - No Change
- } Structural Change

Level 2: Aggregated Pairwise Comparison

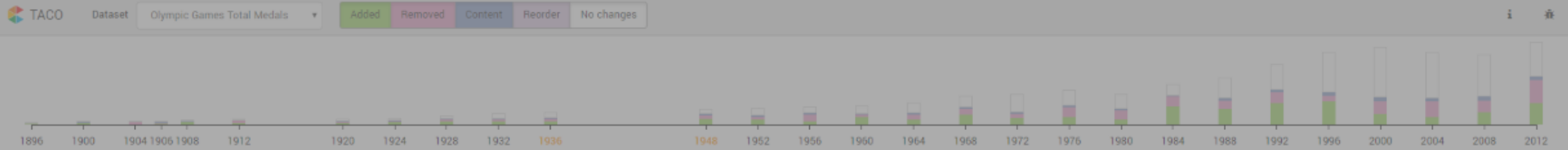

1936
Rows
19 Countries
Columns
36 Disciplines

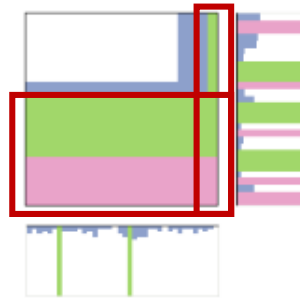

1948
Rows
21 Countries
Columns
38 Disciplines

Level 3: Detailed Pairwise Comparison

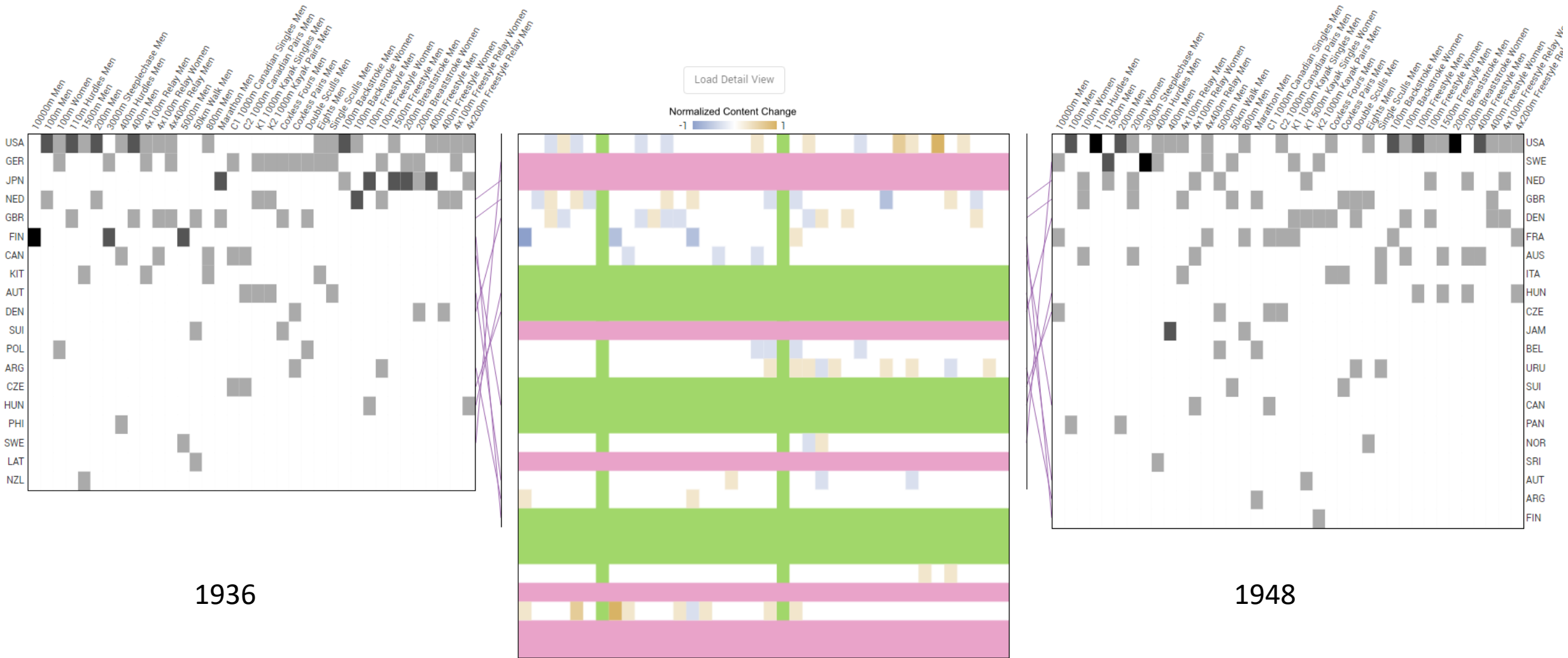

1936

1948

Level 3: Detailed Pairwise Comparison

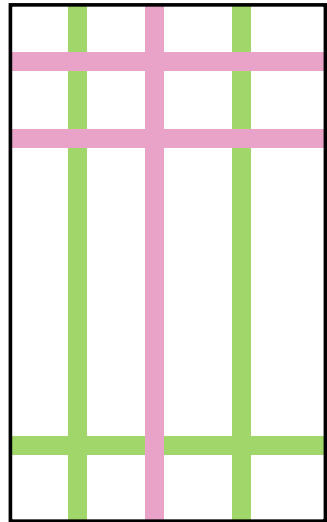

(a) Structure

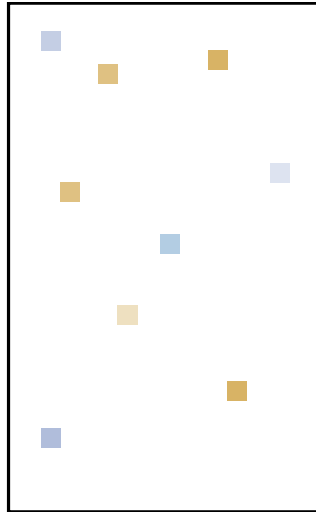

(b) Content

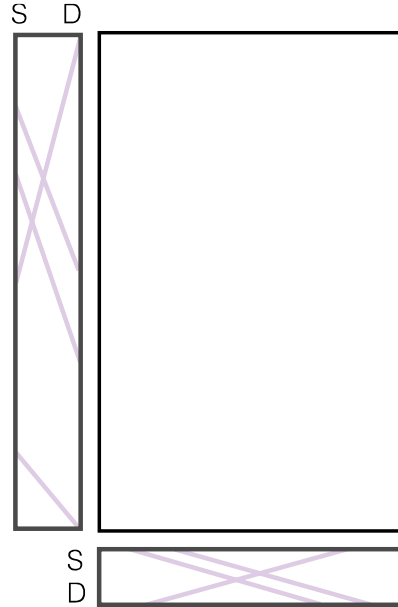

(c) Reorder

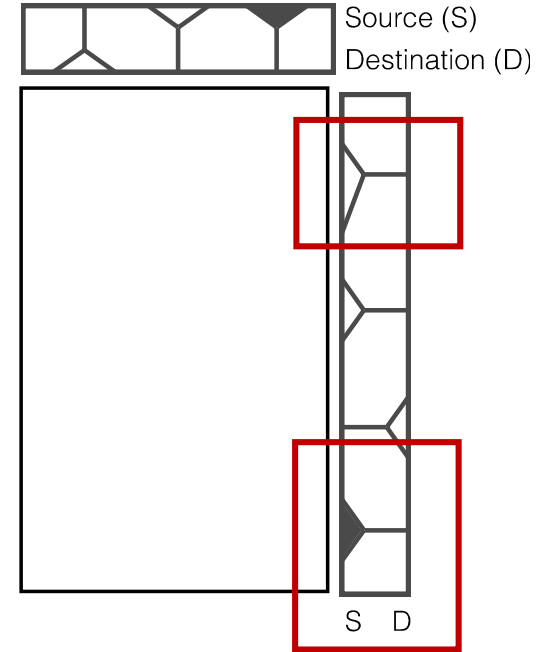

(d) Merge/Split

Legend

 Added Change

 Removed Change

 Content Change 

 No Change

 Reorder Change

Level 3: Detailed Pairwise Comparison

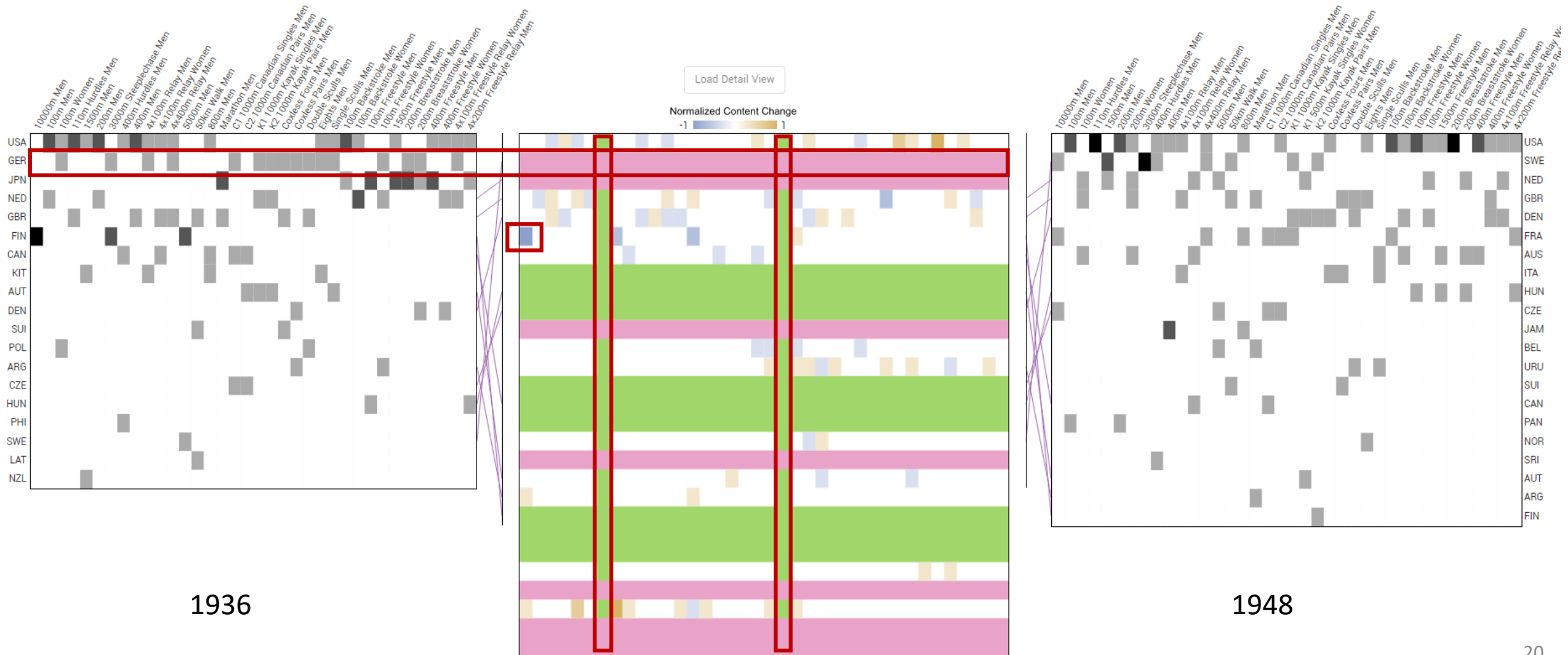

Usage Scenario

Cancer Genomics

571 patients (rows) x 24,174 genes (columns)

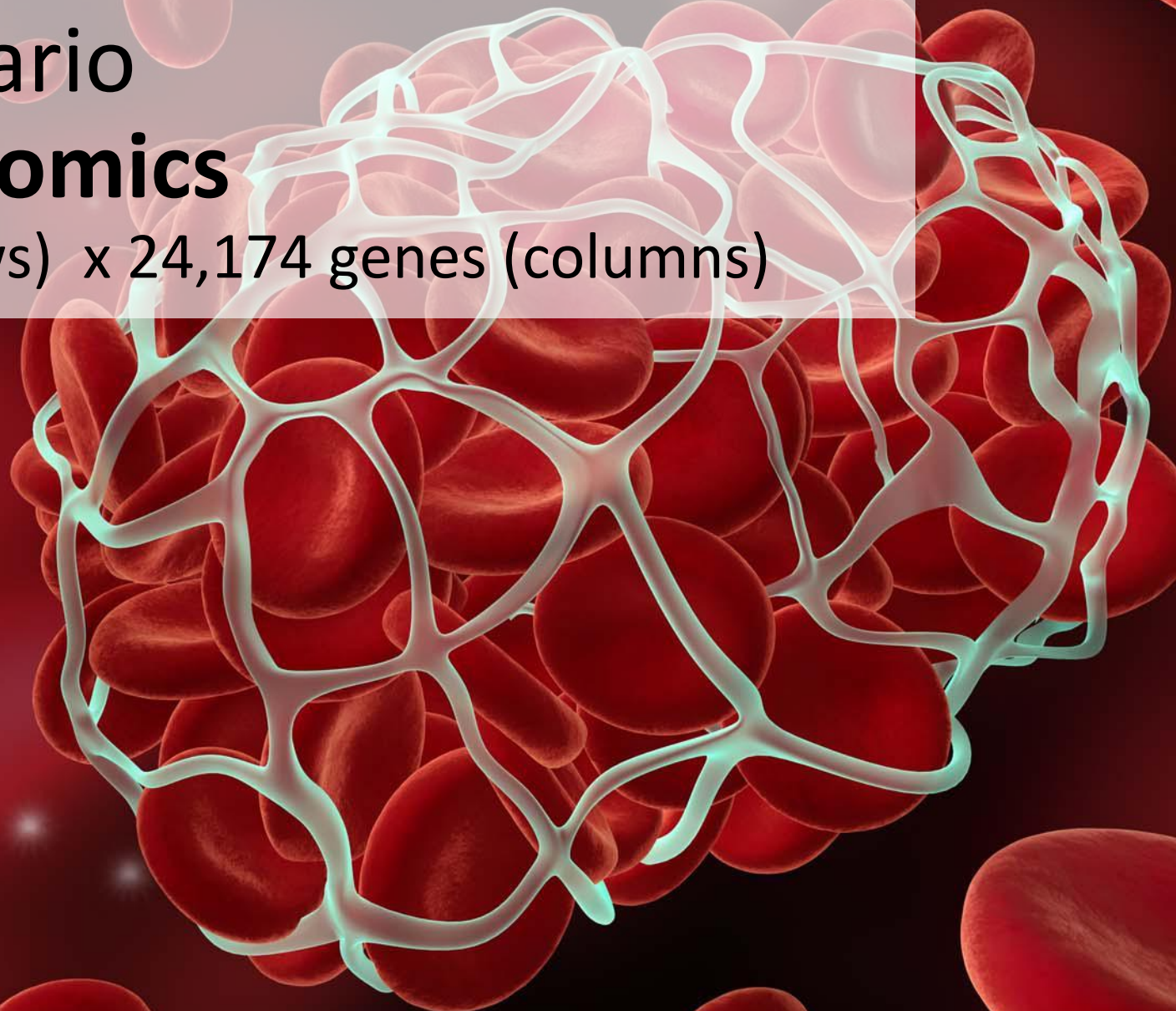

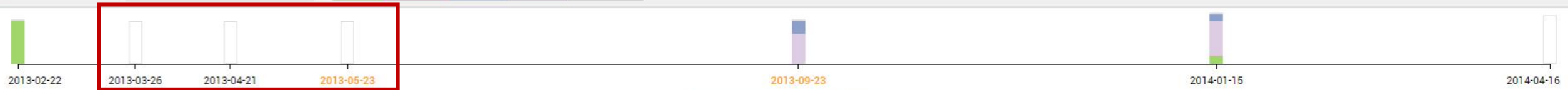

2013-05-23
Rows
491 TCGA_SAMPLES
Columns
150 microRNAs

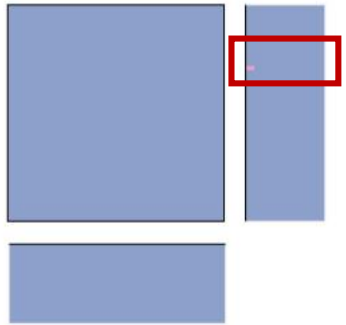

2013-09-23
Rows
490 TCGA_SAMPLES
Columns
150 microRNAs

Load Detail View



Focus on Reorder

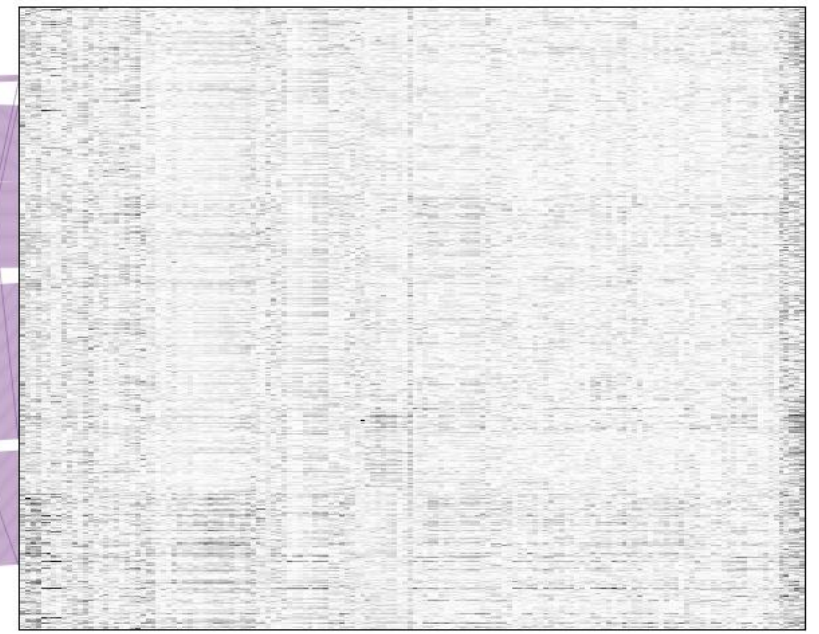
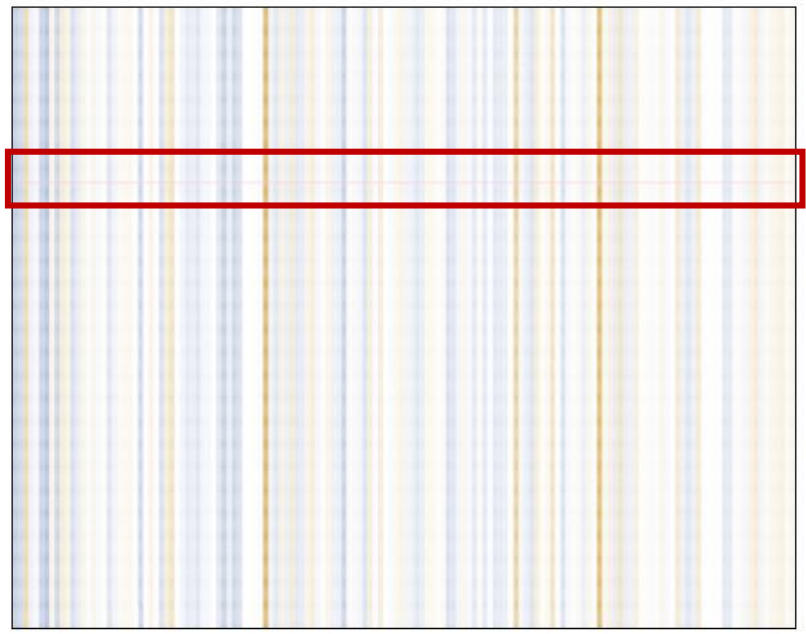
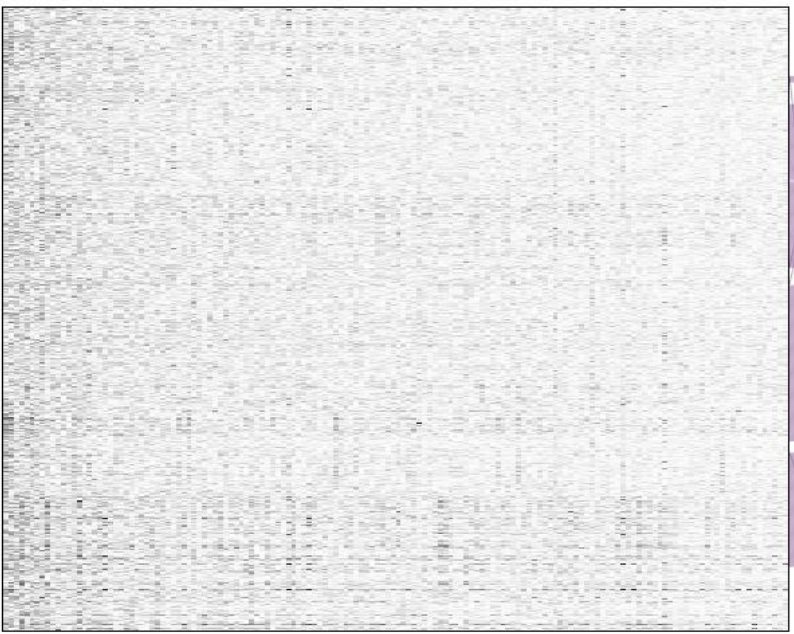

Implementation

Server



Client

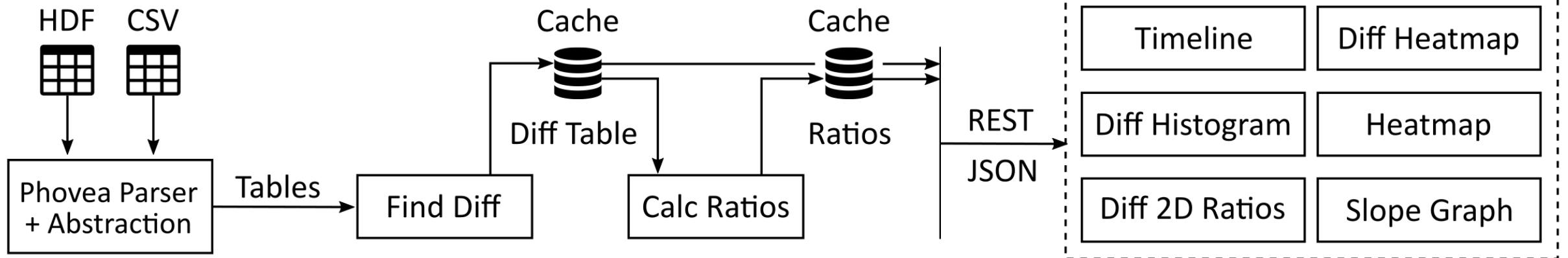

Limitations

Homogenous

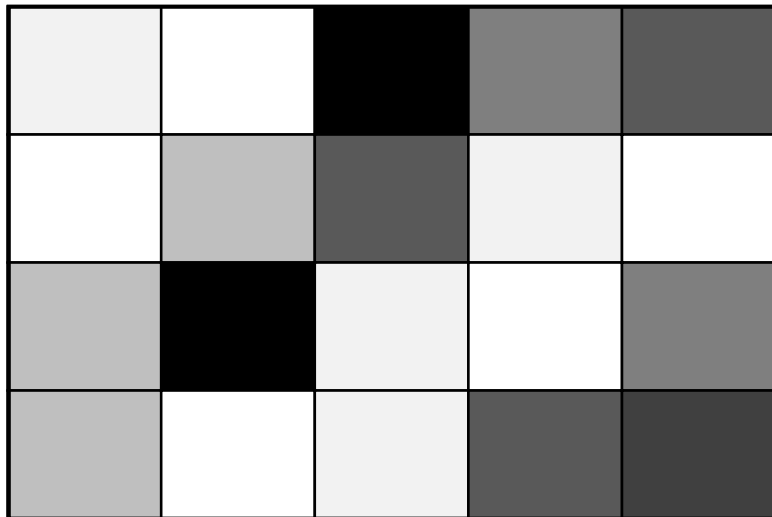

Heterogenous

A	C1		33	G4
B	C1		25	G8
C	C2		9	G8
D	C2		4	G4

- Special Normalization
- Different Visual Encoding

Limitations

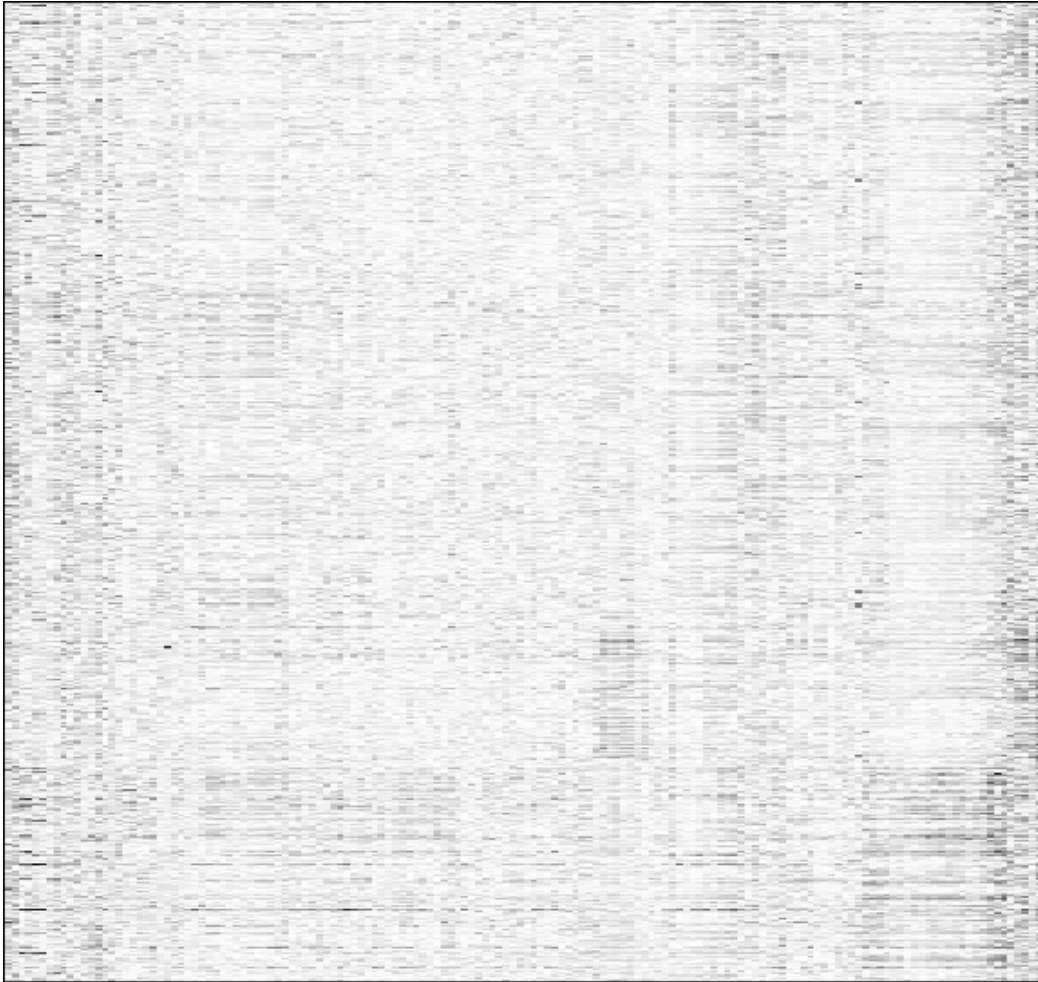

- Cluster matrix in advance
- Aspect ratio
- Sub-pixel representation

TACO: Visualizing Changes in Tables over Time

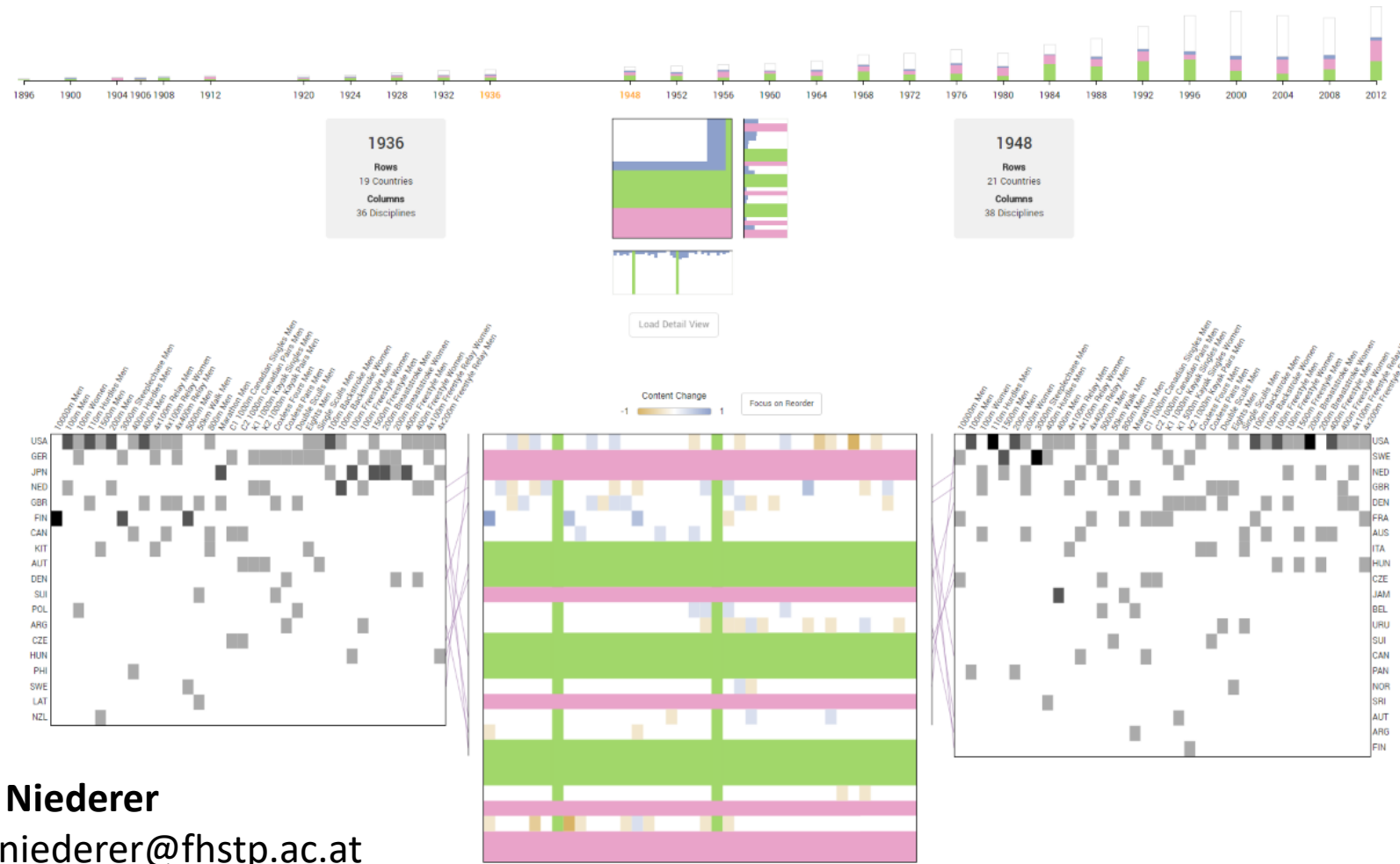

Christina Niederer
christina.niederer@fhstp.ac.at



Holger Stitz
holger.stitz@jku.at

Funded by **FWF**
Der Wissenschaftsfonds.



taco.caleydo.org